

KUADRA A



ANGULAR DE DOS PUERTAS CORREDERAS + DOS FIJOS
CORNER ENTRY SHOWER ENCLOSURE, 2 SLIDING DOORS + 2 FIXED PANELS

Medidas Dimensions			Código Code	Izquierda Left	Derecha Right	Cristales Glass		Perfiles Profile type	
Extensibilidad Actual dimensions	Fijo frontal Fixed panel	Entrada Access		S-	D-	1	51	B	K
A	F1	*				Transparente Clear	Serig. Ravenna Ravenna print.	Silver	Cromo Chrome
68 ↔ 71	31	32	KUADA69L	S-	D-				
71 ↔ 74	33	34	KUADA72L	S-	D-				
74 ↔ 77	34	36	KUADA75L	S-	D-				
77 ↔ 80	36	38	KUADA78L	S-	D-				
83 ↔ 86	39	42	KUADA84L	S-	D-				
86 ↔ 89	40	44	KUADA87L	S-	D-				
89 ↔ 92	42	46	KUADA90L	S-	D-				
95 ↔ 98	45	50	KUADA96L	S-	D-				
98 ↔ 101	46	52	KUADA99L	S-	D-				
107 ↔ 110	51	58	KUADA108L	S-	D-				
116 ↔ 119	55	64	KUADA117L	S-	D-				
119 ↔ 122	57	66	KUADA120L	S-	D-				
H 170 ↓ 200	L 69 ↔ 120		KUADALDSP	Derecha / Right					
H 170 ↓ 200	L 69 ↔ 120	ESPECIAL / SPECIAL	KUADALSSP	Izquierda / Left					

PARA COMPONER UN ÁNGULO PEDIR 2 LATERALES
TO COMPLETE A CORNER ENTRY, ORDER 2 SIDES

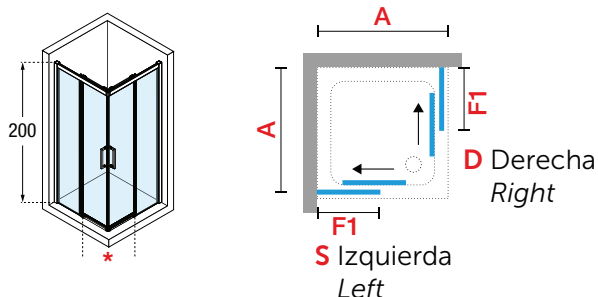

Construcción del código: Código + Izquierda / Derecha + Cristales + Perfiles = Código completo del producto
Construction of the code: Code + Left / Right + Glass + Profile = Final product code



DATOS TÉCNICOS / TECHNICAL DATA

CRISTAL / GLASS TYPES 6 mm (European standards UNI EN 14428)



**Transparente
Clear**

COD. 1

**Espejo
Mirror (Spy)**

COD. 76

SERIGRAFIA PRINTING

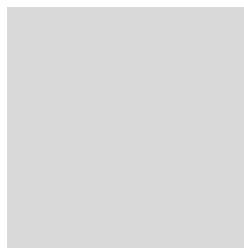

Ravenna

COD. 51

TIRADOR HANDLE

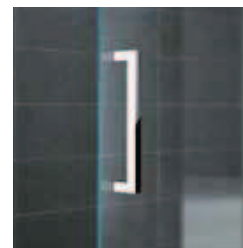

Tirador cromo

Medida entre agujeros de 256 mm

Chromed metal handle

Interaxis 256 mm

COLORES PERFILES / PROFILE COLOURS



Silver

COD. B

**Cromo
Chrome**

COD. K

MEDIDAS QUE OCUPAN LOS PERFILES EN LA PARED / OVERALL DIMENSIONS FIXING PROFILES

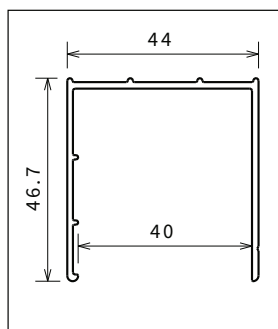

**a pared / wall
A-R**

Color perfil Profile	Código Code
Blanco White	P01KUMO1ST-A
Silver	P01KUMO1ST-B
Cromo Chrome	P01KUMO1ST-K

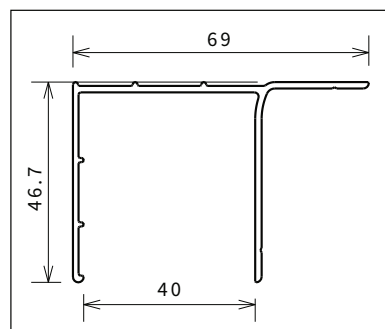

**a pared / wall
2P-G-G+FL-2A**

Color perfil Profile	Código Code
Blanco White	P01KUMO2ST-A
Silver	P01KUMO2ST-B
Cromo Chrome	P01KUMO2ST-K

TOMA DE MEDIDAS / HOW TO TAKE THE MEASUREMENT

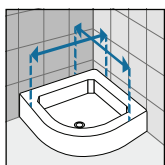
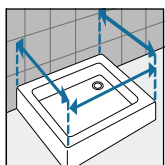
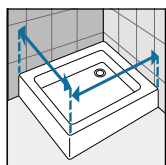

Tomar las medidas desde la pared hasta el borde externo del plato de ducha.

Take the measurements from wall to the external edge of the shower tray. Dimensions must be taken once the walls are finished and tiled, according to the above drawings.

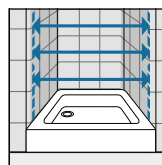

Tomar medidas de pared a pared, medir la parte baja, la central y la superior. Cursar el pedido con la medida más pequeña.

Take the measurements from wall to wall at the bottom, at the top, in the middle and use the smallest. Dimensions must be taken once the walls are finished and tiled, according to the above drawings.