

# YOUNG 2.0 1BS



FRONTAL PLEGABLE SIN GUIAS / PARA INSTALAR ENTRE PAREDES O CON FIJO LATERAL YOUNG 2.0 F1B  
 SHOWER DOOR, 1 HINGED FOLDING DOOR FOR RECESS INSTALLATION

Medidas Dimensions					Código Code	Izquierda Left	Derecha Right	Cristales Glass			Perfiles Profile type			
Extensibilidad Actual dimensions	Entre paredes For recess	Entrada Access	Espacio de apertura Projection					1	2	4	D	B	K	H
A	A1	*	B	B1				Transparente Clear	Aqua	Satinado Satin	Blanco White	Silver	Cromo Chrome	Negro mate Black

## PUERTA / DOOR

58 ↔ 62	57 ↔ 61	41	47	27	Y21BS57	S-	D-							
68 ↔ 72	67 ↔ 71	51	57	32	Y21BS67	S-	D-							
73 ↔ 77	72 ↔ 76	56	62	35	Y21BS72	S-	D-							
78 ↔ 82	77 ↔ 81	61	67	37	Y21BS77	S-	D-	●						
83 ↔ 87	82 ↔ 86	66	72	40	Y21BS82	S-	D-							
88 ↔ 92	87 ↔ 91	71	77	42	Y21BS87	S-	D-	●						
95 ↔ 99	94 ↔ 98	78	84	46	Y21BS94	S-	D-							
98 ↔ 102	97 ↔ 101	81	87	47	Y21BS97	S-	D-	●						
108 ↔ 112	107 ↔ 111	91	97	52	Y21BS107	S-	D-							
118 ↔ 122	117 ↔ 121	101	107	57	Y21BS117	S-	D-							

## PANEL FIJO / SIDE PANEL

F								Transparente Clear	Aqua	Satinado Satin	Blanco White	Silver	Cromo Chrome	Negro mate Black
57 ↔ 59	◇	◇	◇	◇	Y2F1B57-									
59 ↔ 61	◇	◇	◇	◇	Y2F1B59-									
65 ↔ 67	◇	◇	◇	◇	Y2F1B65-									
67 ↔ 69	◇	◇	◇	◇	Y2F1B67-									
69 ↔ 71	◇	◇	◇	◇	Y2F1B69-									
73 ↔ 75	◇	◇	◇	◇	Y2F1B73-									
75 ↔ 77	◇	◇	◇	◇	Y2F1B75-									
76 ↔ 78	◇	◇	◇	◇	Y2F1B76-									
77 ↔ 79	◇	◇	◇	◇	Y2F1B77-			●						
79 ↔ 81	◇	◇	◇	◇	Y2F1B79-			●						
81 ↔ 83	◇	◇	◇	◇	Y2F1B81-									
85 ↔ 87	◇	◇	◇	◇	Y2F1B85-									
87 ↔ 89	◇	◇	◇	◇	Y2F1B87-			●						
89 ↔ 91	◇	◇	◇	◇	Y2F1B89-			●						
91 ↔ 93	◇	◇	◇	◇	Y2F1B91-									
95 ↔ 97	◇	◇	◇	◇	Y2F1B95-									
97 ↔ 99	◇	◇	◇	◇	Y2F1B97-			●						
99 ↔ 101	◇	◇	◇	◇	Y2F1B99-									
101 ↔ 103	◇	◇	◇	◇	Y2F1B101-									
117 ↔ 119	◇	◇	◇	◇	Y2F1B117-									
119 ↔ 121	◇	◇	◇	◇	Y2F1B119-									

H 140 ↓ 200 L 20 ↔ 120

ESPECIAL / SPECIAL Y2F1BSP

El fijo especial se debe pedir con la misma altura de la puerta.  
 Special side panel must be ordered the same height of the door

● Entrega en un plazo máximo de 7 días.  
 Delivery within 7 business days.

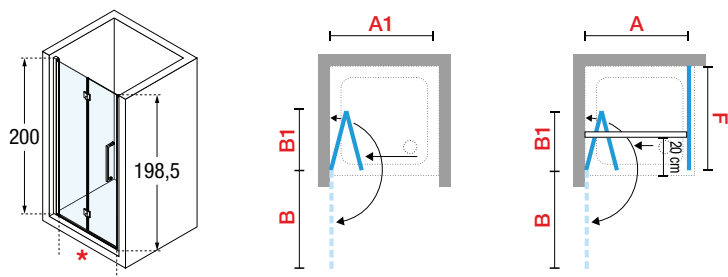

Barra de sujeción a pared de 150 cm. INCLUIDA  
 Standard support bar supplied on 150 cm

Construcción del código: Código Code + Izquierda / Derecha Left / Right + Cristales Glass + Perfiles Profile = Código completo del producto Final product code



## OPCIONAL / OPTIONAL



### Barra estabilizador Support bar

Medidas Dimensions	Código Code
15 cm	R80LOU150-K
25 cm	R80LOU250-K
35 cm	R80LOU350-K
45 cm	R80LOU450-K



### Barra de sujeción 150 cm Support bar 150 cm length

Color Colour	Código Code
Blanco / White	R80Y215-D
Silver	R80Y215-B
Cromo / Chrome	R80Y215-K
Dorado / Gold	R80Y215-O
Negro / Black	R80Y215-H



### Kit Barra orientable (contiene)

- 1 barra de 100 cms
- 1 pieza sujeción a muro
- 1 pieza de fijación al cristal

#### Adjustable bar kit

- 1 adjustable bar of 100cm (shortened)
- 1 wall attachment
- 1 glass clamp

Color Colour	cm	Código Code
Blanco / White	100	R80KUOR100-D
Silver		R80KUOR100-B
Cromo / Chrome		R80KUOR100-K



### Kit barra en "T"

barra de sujeción de 150 cm para unir a la barra suministrada con el fijo

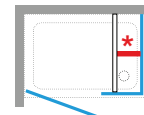

#### "T" bar kit

Support bar of 150 cm to match with the supplied bar for T solution

Color Colour	Código Code
Blanco / White	R80Y215T-D
Silver	R80Y215T-B
Cromo / Chrome	R80Y215T-K
Dorado / Gold	R80Y215T-O
Negro / Black	R80Y215T-H



### Nuevo sistema estabilizador EVO (ángulo)

- Barra frontal de 180 cms
- Barra lateral de 120 cms
- Piezas para sujeción a pared
- 1 pieza para la unión angular

#### EVO fixing system (corner)

- 1 front bar of 180 cm
- 1 side bar of 120 cm
- 2 clamps
- 1 angular union
- Piezas para sujeción a pared
- 1 pieza para la unión angular

Color perfil Profile	Código Code
Silver	KUADHSF-B
Cromo / Chrome	KUADHSF-K

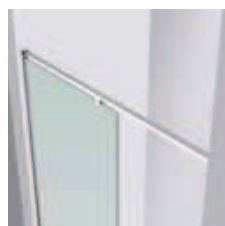

### Nuevo sistema estabilizador EVO (entre paredes)

- Barra frontal de 180 cms
- Pieza para sujeción a pared

#### EVO fixing system

- 1 front bar of 180 cm
- 2 clamps

Color Colour	Código Code
Silver	KUADHSFN-B
Cromo / Chrome	KUADHSFN-K
Negro / Black	KUADHSFN-H

## DATOS TÉCNICOS / TECHNICAL DATA

### CRISTAL / GLASS TYPES

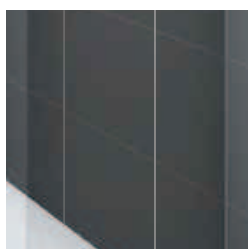

**Transparente**  
**Clear**

COD. 1



**Aqua**

COD. 2



**Satinado fosco**  
**Satin**

COD. 4

### TIRADOR / HANDLES



**Tirador cromo**  
**Chromed metal handles**

### COLORES PERFILES / PROFILE COLOURS

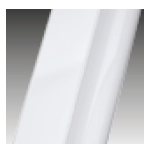

**Blanco**  
**White**

COD. D



**Silver**

COD. B



**Cromo**  
**Chrome**

COD. K



**Negro**  
**Black**

COD. H

### MEDIDAS QUE OCUPAN LOS PERFILES EN LA PARED / OVERALL DIMENSIONS FIXING PROFILES

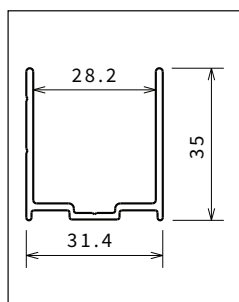

**A pared / Wall**

Altura Height	Perfiles Perfis	Código Code
1984	Blanco / White	P01BNMOBST-A
	Silver	P01BNMOBST-B
	Cromo / Chrome	P01BNMOBST-K
	Negro / Black	P01BNMOBST-H
2000	Blanco / White	P01BNMOAST-A
	Silver	P01BNMOAST-B
	Cromo / Chrome	P01BNMOAST-K
	Negro / Black	P01BNMOAST-H

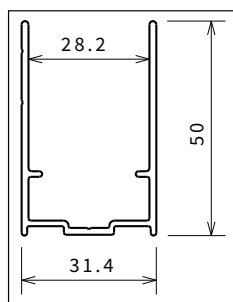

**Compensadores / Compensatory**

En lugar del perfil pared (+15 mm)

*Deeper wall profile (+ 15 mm adjustability)*

Altura Height	Perfiles Profile	Código Code
1984	Blanco / White	P05Y2ST-A
	Silver	P05Y2ST-B
	Cromo / Chrome	P05Y2ST-K
	Negro / Black	P05Y2ST-H
2000	Blanco / White	P05Y2ST2-A
	Silver	P05Y2ST2-B
	Cromo / Chrome	P05Y2ST2-K
	Negro / Black	P05Y2ST2-H

### TOMA DE MEDIDAS / HOW TO TAKE THE MEASUREMENTS

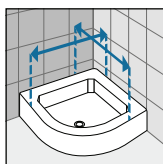
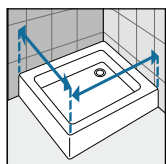

Tomar las medidas desde la pared hasta el borde externo del plato de ducha.

*Take the measurements from wall to the external edge of the shower tray. Dimensions must be taken once the walls are finished and tiled, according to the above drawings.*

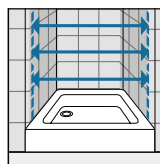

Tomar medidas de pared a pared, medir la parte baja, la central y la superior. Cursar el pedido con la medida más pequeña.

*Take the measurements from wall to wall at the bottom, at the top, in the middle and use the smallest. Dimensions must be taken once the walls are finished and tiled, according to the above drawings.*

# DIBUJOS TÉCNICOS / TECHNICAL DRAWINGS

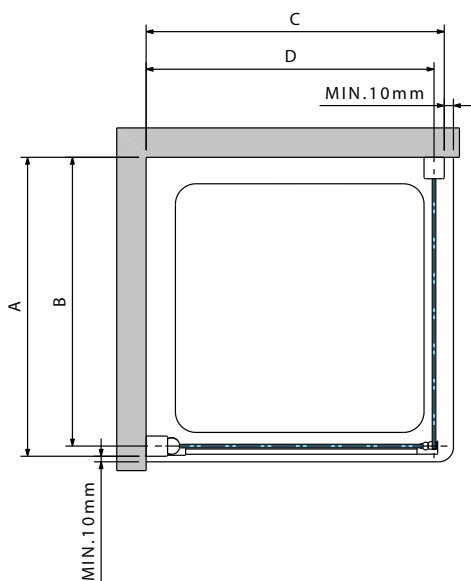

## YOUNG 2.0 G+F

Código / Code	C	D
Y2G57-	57-59	55,4-57,4
Y2G59-	59-61	57,4-59,4
Y2G61-	61-63	59,4-61,4
Y2G65-	65-67	63,4-65,4
Y2G67-	67-69	65,4-67,4
Y2G69-	69-71	67,4-69,4
Y2G72-	72-74	70,4-72,4
Y2G74-	74-76	72,4-74,4
Y2G77-	77-79	75,4-77,4
Y2G79-	79-81	77,4-79,4
Y2G85-	85-87	83,4-85,4
Y2G87-	87-89	85,4-87,4
Y2G89-	89-91	87,4-89,4
Y2G95-	95-97	93,4-95,4
Y2G97-	97-99	95,4-97,4
Y2G99-	99-101	97,4-99,4

## YOUNG 2.0 F

Código / Code	A	B
Y2FG57-	57-59	55,4-57,4
Y2FG59-	59-61	57,4-59,4
Y2FG61-	61-63	59,4-61,4
Y2FG65-	65-67	63,4-65,4
Y2FG67-	67-69	65,4-67,4
Y2FG69-	69-71	67,4-69,4
Y2FG73-	73-75	71,4-73,4
Y2FG75-	75-77	73,4-75,4
Y2FG77-	77-79	75,4-77,4
Y2FG79-	79-81	77,4-79,4
Y2FG85-	85-87	83,4-85,4
Y2FG87-	87-89	85,4-87,4
Y2FG89-	89-91	87,4-89,4
Y2FG95-	95-97	93,4-95,4
Y2FG97-	97-99	95,4-97,4
Y2FG99-	99-101	97,4-99,4
Y2FG117-	117-119	115,4-117,4
Y2FG119-	119-121	117,4-119,4

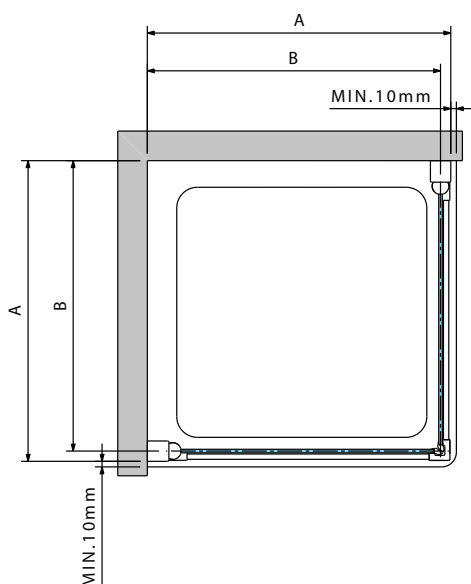

## YOUNG 2.0 2G

Código / Code	C	D
Y22G57	57-59	55,4-57,4
Y22G59	59-61	57,4-59,4
Y22G61	61-63	59,4-61,4
Y22G65	65-67	63,4-65,4
Y22G67	67-69	65,4-67,4
Y22G69	69-71	67,4-69,4
Y22G72	72-74	70,4-72,4
Y22G74	74-76	72,4-74,4
Y22G77	77-79	75,4-77,4
Y22G79	79-81	77,4-79,4
Y22G85	85-87	83,4-85,4
Y22G87	87-89	85,4-87,4
Y22G89	89-91	87,4-89,4
Y22G95	95-97	93,4-95,4
Y22G97	97-99	95,4-97,4
Y22G99	99-101	97,4-99,4

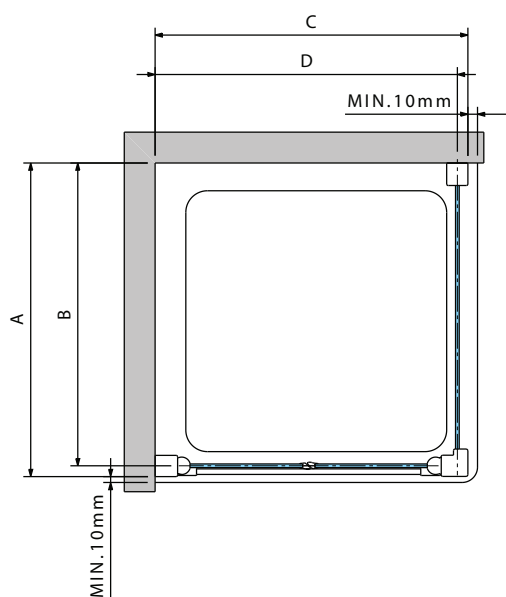

## YOUNG 2.0 2B+F2B

Código / Code	C	D
Y22B57-	58-62	56,6-60,4
Y22B63-	64-68	62,6-66,4
Y22B67-	68-72	66,6-70,4
Y22B71-	72-76	70,6-74,4
Y22B73-	74-78	72,6-76,4
Y22B77-	78-82	76,6-80,4
Y22B83-	84-88	82,6-86,4
Y22B87-	91-95	86,6-90,4
Y22B93-	94-98	92,6-96,4
Y22B97-	98-102	96,6-100,4
Y22B103-	104-108	102,6-106,4
Y22B107-	108-112	106,6-110,4
Y22B113-	114-118	112,6-116,4
Y22B117-	118-122	116,6-120,4
Y22B137-	138-142	136,6-140,4
Y22B147-	148-152	146,6-150,4
Y22B157-	158-162	156,6-160,4
Y22B167-	168-172	166,6-170,4
Y22B177-	178-182	176,6-180,4

## YOUNG 2.0 F2B

Código / Code	C	D
Y2F2B57-	57-59	55,4-57,4
Y2F2B59-	59-61	57,4-59,4
Y2F2B65-	56-58	54,4-56,4
Y2F2B67-	67-69	65,4-67,4
Y2F2B69-	82-86	67,4-69,4
Y2F2B73-	73-75	71,4-73,4
Y2F2B75-	92-96	73,4-75,4
Y2F2B77-	77-79	75,4-77,4
Y2F2B79-	79-81	77,4-79,4
Y2F2B85-	85-87	83,4-85,4
Y2F2B87-	87-89	85,4-87,4
Y2F2B89-	89-91	87,4-89,4
Y2F2B95-	95-97	93,4-95,4
Y2F2B97-	97-99	95,4-97,4
Y2F2B99-	99-101	97,4-99,4
Y2F2B117-	117-119	115,4-117,4
Y2F2B119-	119-121	117,4-119,4

## DIBUJOS TÉCNICOS / TECHNICAL DRAWINGS

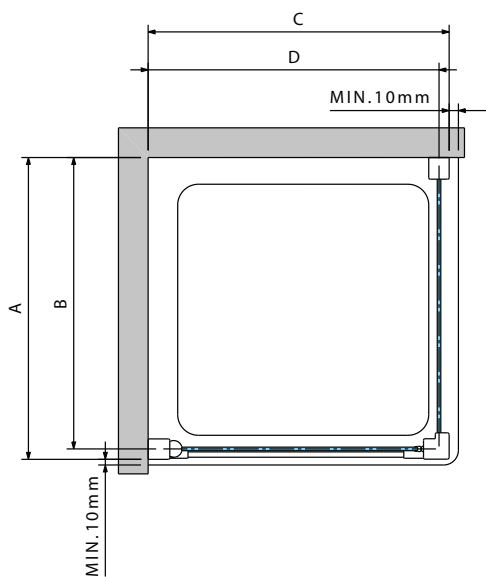

### YOUNG 2.0 1B+F1B

Código / Code	C	D
Y21B57-	58-62	56,4-60,4
Y21B67-	68-72	66,4-70,4
Y21B72-	73-77	71,4-75,4
Y21B77-	78-82	76,4-80,4
Y21B82-	83-87	81,4-85,4
Y21B87-	88-92	86,4-90,4
Y21B92-	93-97	91,4-95,4
Y21B97-	98-102	96,4-100,4

### YOUNG 2.0 F1B

Código / Code	A	B
Y2F1B57-	57-59	55,4-57,4
Y2F1B59-	59-61	57,4-59,4
Y2F1B65-	65-67	63,4-65,4
Y2F1B67-	67-69	65,4-67,4
Y2F1B69-	69-71	67,4-69,4
Y2F1B73-	73-75	71,4-73,4
Y2F1B75-	75-77	73,4-75,4
Y2F1B77-	77-79	75,4-77,4
Y2F1B79-	79-81	77,4-79,4
Y2F1B85-	85-87	83,4-85,4
Y2F1B87-	87-89	85,4-87,4
Y2F1B89-	89-91	87,4-89,4
Y2F1B95-	95-97	93,4-95,4
Y2F1B97-	97-99	95,4-97,4
Y2F1B99-	99-101	97,4-99,4
Y2F1B117-	117-119	115,4-117,4
Y2F1B119-	119-121	117,4-119,4

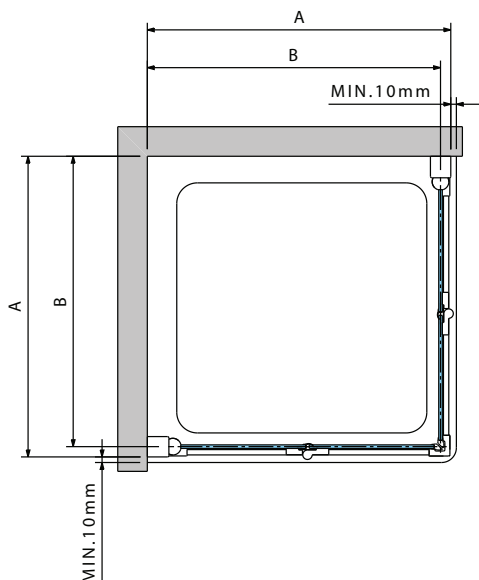

### YOUNG 2.0 2GS

Código / Code	A	B
Y22GS57L	57-59	55,4-57,4
Y22GS59L	59-61	57,4-59,4
Y22GS65L	65-67	63,4-65,4
Y22GS67L	67-69	65,4-67,4
Y22GS69L	69-71	67,4-69,4
Y22GS73L	73-75	71,4-73,4
Y22GS75L	75-77	73,4-75,4
Y22GS77L	77-79	75,4-77,4
Y22GS79L	79-81	77,4-79,4
Y22GS85L	85-87	83,4-85,4
Y22GS87L	87-89	85,4-87,4
Y22GS89L	89-91	87,4-89,4
Y22GS95L	95-97	93,4-95,4
Y22GS97L	97-99	95,4-97,4
Y22GS99L	99-101	97,4-99,4
Y22GS105L	105-107	103,4-105,4
Y22GS115L	115-117	113,4-115,4
Y22GS117L	117-119	115,4-117,4
Y22GS119L	119-121	117,4-119,4

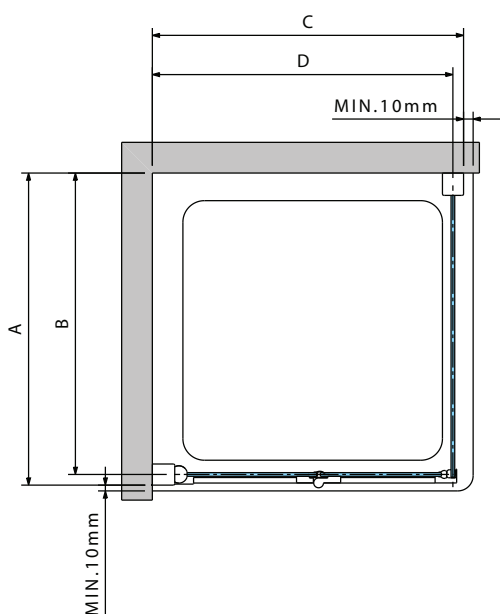

## YOUNG 2.0 2GS+F

Código / Code	C	D
Y22GS57L	58-60	56,4-58,4
Y22GS59L	60-62	58,4-60,4
Y22GS65L	66-68	64,4-66,4
Y22GS67L	68-70	66,4-68,4
Y22GS69L	70-72	68,4-70,4
Y22GS73L	74-76	72,4-74,4
Y22GS75L	76-78	74,4-76,4
Y22GS77L	78-80	76,4-78,4
Y22GS79L	80-82	78,4-80,4
Y22GS85L	86-88	84,4-86,4
Y22GS87L	88-90	86,4-88,4
Y22GS89L	90-92	88,4-90,4
Y22GS95L	96-98	94,4-96,4
Y22GS97L	98-100	96,4-98,4
Y22GS99L	100-102	98,4-100,4
Y22GS105L	106-108	104,4-106,4
Y22GS115L	116-118	114,4-116,4
Y22GS117L	118-120	116,4-118,4
Y22GS119L	120-122	118,4-120,4

## YOUNG 2.0 F

Código / Code	A	B
Y2FG57-	57-59	55,4-57,4
Y2FG59-	59-61	57,4-59,4
Y2FG61-	61-63	59,4-61,4
Y2FG65-	65-67	63,4-65,4
Y2FG67-	67-69	65,4-67,4
Y2FG69-	69-71	67,4-69,4
Y2FG73-	73-75	71,4-73,4
Y2FG75-	75-77	73,4-75,4
Y2FG77-	77-79	75,4-77,4
Y2FG79-	79-81	77,4-79,4
Y2FG85-	85-87	83,4-85,4
Y2FG87-	87-89	85,4-87,4
Y2FG89-	89-91	87,4-89,4
Y2FG95-	95-97	93,4-95,4
Y2FG97-	97-99	95,4-97,4
Y2FG99-	99-101	97,4-99,4
Y2FG117-	117-119	115,4-117,4
Y2FG119-	119-121	117,4-119,4



## DIBUJOS TÉCNICOS / TECHNICAL DRAWINGS

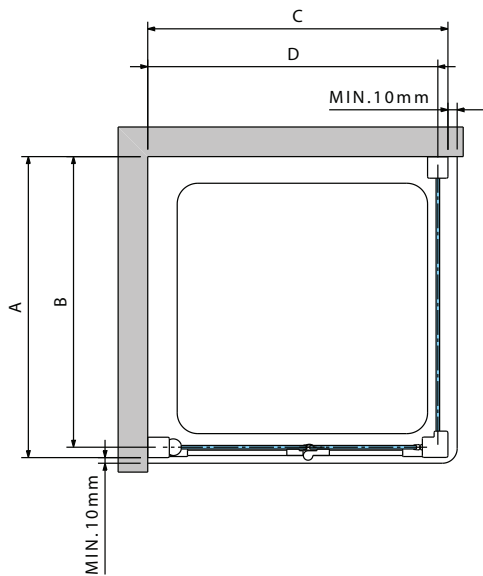

### YOUNG 2.0 1BS+F1B

Código / Code	C	D
Y21BS57	58-62	56,4-60,4
Y21BS67	68-72	66,4-70,4
Y21BS72	73-77	71,4-75,4
Y21BS77	78-82	76,4-80,4
Y21BS82	83-87	81,4-85,4
Y21BS87	88-92	86,4-90,4
Y21BS94	95-99	93,4-97,4
Y21BS97	98-102	96,4-100,4
Y21BS107	107-112	106,4-110,4
Y21BS117	118-122	116,4-120,4

### YOUNG 2.0 F1B

Código / Code	A	B
Y2F1B57-	57-59	55,4-57,4
Y2F1B59-	59-61	57,4-59,4
Y2F1B65-	65-67	63,4-65,4
Y2F1B67-	67-69	65,4-67,4
Y2F1B69-	69-71	67,4-69,4
Y2F1B73-	73-75	71,4-73,4
Y2F1B75-	75-77	73,4-75,4
Y2F1B77-	77-79	75,4-77,4
Y2F1B79-	79-81	77,4-79,4
Y2F1B85-	85-87	83,4-85,4
Y2F1B87-	87-89	85,4-87,4
Y2F1B89-	89-91	87,4-89,4
Y2F1B95-	95-97	93,4-95,4
Y2F1B97-	97-99	95,4-97,4
Y2F1B99-	99-101	97,4-99,4
Y2F1B117-	117-119	115,4-117,4
Y2F1B119-	119-121	117,4-119,4

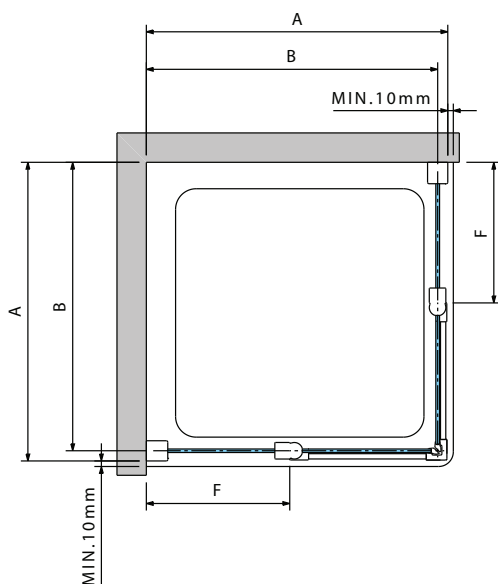

### YOUNG 2.0 A

Código / Code	F	A	B
Y2A57L-	27	57-59	55,4-57,4
Y2A59L-	27	59-61	57,4-59,4
Y2A61L-	27	61-63	59,4-61,4
Y2A65L-	27	65-67	63,4-65,4
Y2A67L-	27	67-69	65,4-67,4
Y2A69L-	27	69-71	67,4-69,4
Y2A73L-	35	73-75	71,4-73,4
Y2A75L-	35	75-77	73,4-75,4
Y2A77L-	35	77-79	75,4-77,4
Y2A79L-	35	79-81	77,4-79,4
Y2A85L-	43	85-87	83,4-85,4
Y2A87L-	43	87-89	85,4-87,4
Y2A89L-	43	89-91	87,4-89,4
Y2A95L-	43	95-97	93,4-95,4
Y2A97L-	43	97-99	95,4-97,4
Y2A99L-	43	99-101	97,4-99,4

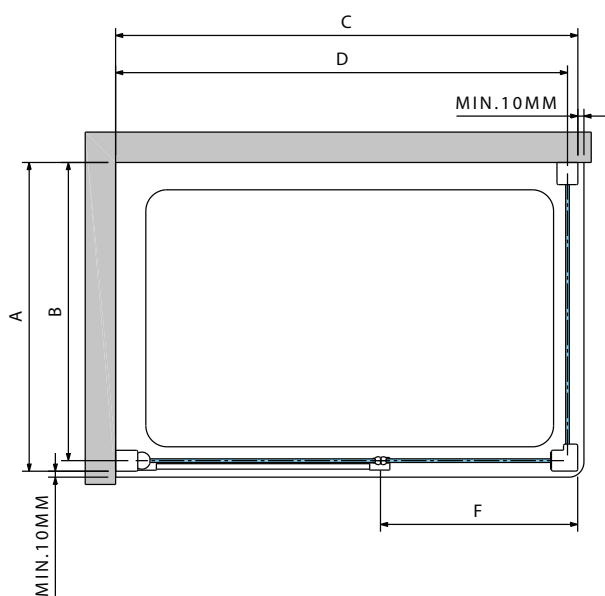

## YOUNG 2.0 GFL+F1B

Código / Code	F	C	D
Y2GFL97	32,5	98-102	96,4-100,4
Y2GFL107	42,5	108-112	106,4-110,4
Y2GFL114	39,5	115-119	113,4-117,4
Y2GFL117	42,5	118-122	116,4-120,4
Y2GFL134	49,5	135-139	133,4-137,4
Y2GFL137	52,5	138-142	136,4-140,4
Y2GFL147	52,5	148-153	146,4-150,4
Y2GFL154	59,5	155-159	153,4-157,4
Y2GFL157	62,5	158-162	156,4-160,4
Y2GFL164	69,5	165-169	163,4-167,4
Y2GFL167	72,5	168-172	166,4-170,4
Y2GFL177	82,5	178-182	176,4-180,4

## YOUNG 2.0 F1B

Código / Code	A	B
Y2F1B57-	57-59	55,4-57,4
Y2F1B59-	59-61	57,4-59,4
Y2F1B65-	65-67	63,4-65,4
Y2F1B67-	67-69	65,4-67,4
Y2F1B69-	69-71	67,4-69,4
Y2F1B73-	73-75	71,4-73,4
Y2F1B75-	75-77	73,4-75,4
Y2F1B77-	77-79	75,4-77,4
Y2F1B79-	79-81	77,4-79,4
Y2F1B85-	85-87	83,4-85,4
Y2F1B87-	87-89	85,4-87,4
Y2F1B89-	89-91	87,4-89,4
Y2F1B95-	95-97	93,4-95,4
Y2F1B97-	97-99	95,4-97,4
Y2F1B99-	99-101	97,4-99,4
Y2F1B117-	117-119	115,4-117,4
Y2F1B119-	119-121	117,4-119,4