

PRODUKTBLAD

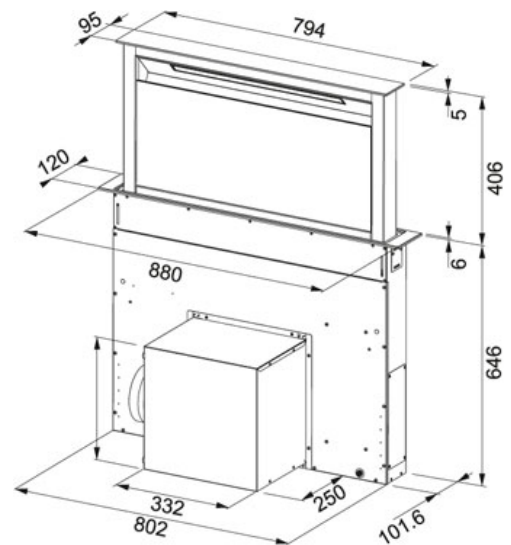







PRODUCT FAMILY: Hoods FINISH: Stainless Steel-Glass Black SERIES: DOWNDRAFT MODEL: FDW 908 IB XS



Produkt info

Artikel nummer	110.0260.620
Energieeffektivitetsklasse	C
Hood Type Sweden	Designkupa
Hood Type	Downdraft
Width Hood in cm	88
Number of speeds	4+int.
Capacity DIN IEC 61591 Int.	710 m ³ /h
Capacity DIN IEC 61591 Max.	530 m ³ /h
Capacity DIN IEC 61591 Min.	220 m ³ /h
Noiselevel DIN EN 60704-3 Int.	70 dB(A)
Noiselevel DIN EN 60704-3 Max.	65 dB(A)
Noiselevel DIN EN 60704-3 Min.	46 dB(A)
Power (W)	275 W
Illumination	LED bar 1x10W
Type of Controls	Electronic touch control
Outlet tube diameter	Ø 150 mm
Utvendige mål	880

Annet

	Filtering Function		Filter Saturation Indicator
	Perimetric Extraction		Energy Motor
	Timer		Digital Display
	4 Speed + Intensive		Energieeffektivitetsklass C